

Metalunic® External Venetian Blinds. Technology, options, applications.

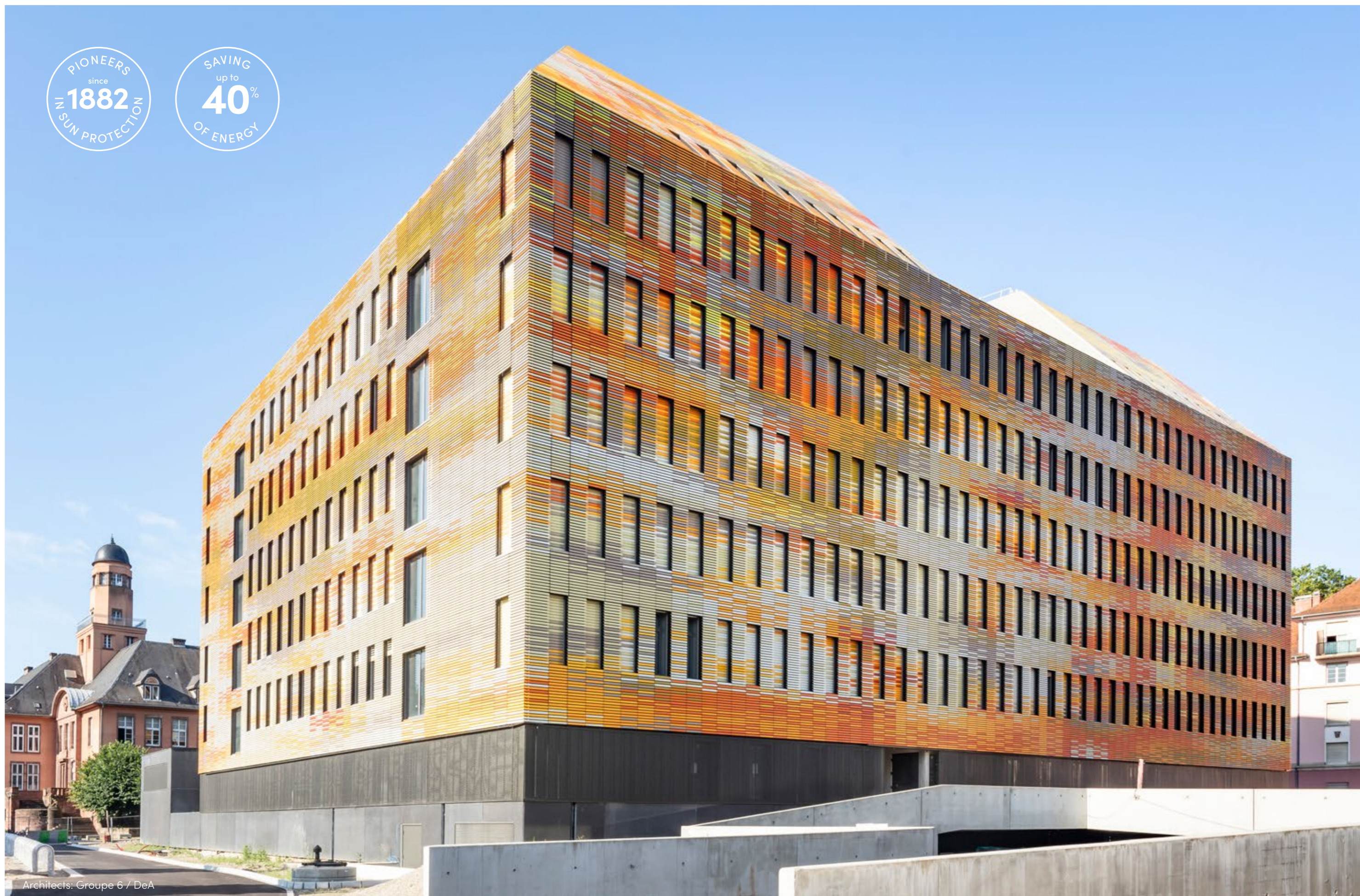

PIONEERS
since
1882
IN SUN PROTECTION

SAVING
up to
40%
OF ENERGY



Architects: Groupe 6 / DeA



Metalunic® Venetian blinds.

A top-notch product: Griesser's Metalunic® venetian blinds deliver an optimum combination of solar shading, security and aesthetic appeal. The slats are tilted directly in the guides, allowing them to be set at any angle desired. Metalunic® blinds are made entirely of metal and are the finest in their class. Their fully concealed operating mechanism ensures unencumbered views. And their robust slat profile offers both outstanding elegance and an ideal vehicle for setting architectural accents.



Optimum light management.

Metalunic® slats can be set to any angle. So you can decide how much light to let into each room. Children, for instance, are known to learn better in natural light.



Save energy.

Save up to 40% energy in summer and reduce your heating costs in winter thanks to intelligent daylight control. You can find the latest studies and research results on this topic here: www.es-so.com



Unobstructed views.

Daylight has a huge effect on the productivity, the health and the general well-being of anyone working in an indoor environment.



Outstanding design.

Opt for style. With its vast range of venetian blind models, systems and options, Griesser is a byword for sleek and straightforward design.



High wind resistance.

Griesser's venetian blinds are provenly wind-resistant, with some models capable of withstanding wind strengths of 92 km/h or more.

Technical highlights.

With their self-supporting all-metal construction, Metalunic® venetian blinds are made to stand strong. Their robust slat profile offers both outstanding elegance and an ideal means of setting architectural accents. And at 20,000 cycles, Griesser subjects its Metalunic® products to twice the tests required under the applicable norms.



- 1 A self-supporting blind system.**
Facade insulation remains intact and noise transmissions are reduced.



- 2 No visible vertical connections.**
For unencumbered views.



- 3 Safety locking.**
Metalunic®'s anti-intrusion safety locking functions in every blind position.



- 4 Safety sensing edge.**
The built-in safety sensing edge ensures that the blind will stop as soon as it encounters any obstacle.



- 5 Soft closing as standard.**
With its gentle movement, Comfort Drive enables the slats to be precisely positioned and ensures exact light regulation, while the slow speed approaching final position makes closing the blind an almost silent operation.



- 6 Work Setting standard.**
With the Work Setting, the system's slats will maintain an angle of around 45 or 70 degrees as the blind is lowered, to avoid the inconvenient darkening of the room during the lowering process.



- 7 Clip-out slats.**
Metalunic® slats can be individually replaced.

Installation locations.

Metalunic® is a highly versatile system that can be installed in a wide range of construction contexts and will fit perfectly into virtually any facade.



1 Metalunic® with cover.

If no header niche is available, the whole system housing can be concealed behind a cover.

3 On the facade.

With appropriate bracketing, Metalunic® products can be installed directly onto (and slightly protruding from) the facade. Various cover options are available to ensure an optimum visual finish.

5 Metalunic® Standard.

In header niche.

6 Metalunic® Sinus.

In header niche.

7 Metalunic® Fix combined.

Multiple products used side by side can also be combined. Up to four products can be connected in this way, up to a maximum width of 8.4 m and a maximum area of 4.8 m². The prime benefit of such combined units: they only require a single drive.

Options.

With the available options, you can modify your product according to your ideas and to your individual requirements.

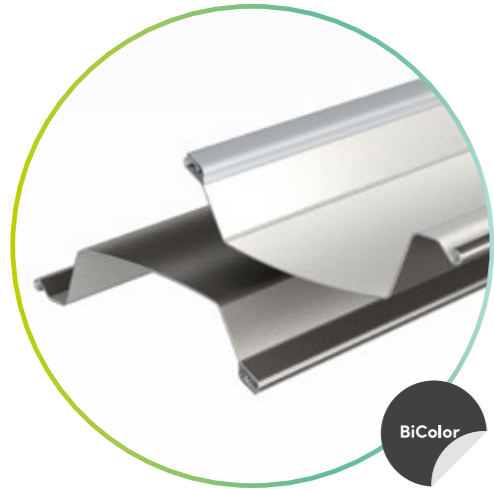

BiColor.

With our BiColor option, you can choose one color for the outward side of your slats that helps your blinds fit harmoniously into your building's facade, and another color for the inward side that matches the tones of your room.

Exclusively from Griesser.

Note: With the BiColor version, a narrow strip of the outer color is visible on the inside of the blind for each slat.

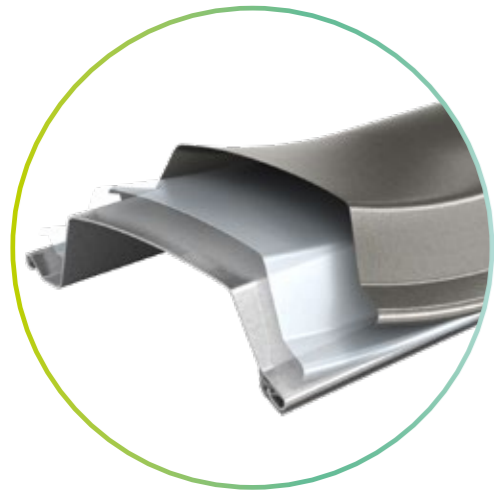

ProtectPLUS.

Challenging air conditions by the sea or in locations with extensive air pollution can make great demands on slatted products. Additional coatings on the slats concerned can protect them from filiform corrosion. Nickel-plated chains are used instead of the standard type.



Variants.

Metalunic® is available in different variants, which means that it can be optimally customized to your needs.

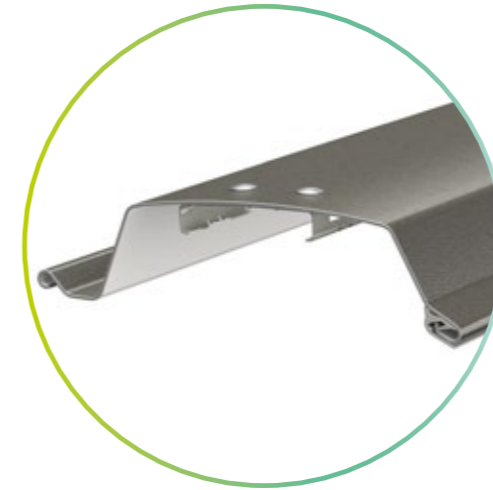

Metalunic® Standard.

- Robust profile with sealing lip.
- Damaged slats can be individually replaced.
- Curved and double-flanged, 96 mm wide.



Metalunic® Sinus.

- Sinus slats deliver up to 50% more daylight into the interior.
- With their wave-like form, the slats better direct light up to the ceiling while avoiding lower-level glare.
- Damaged slats can be individually replaced.
- Curved and double-flanged, 92.6 mm wide.

Covers. **Open header.**

1.1 Straight cover.

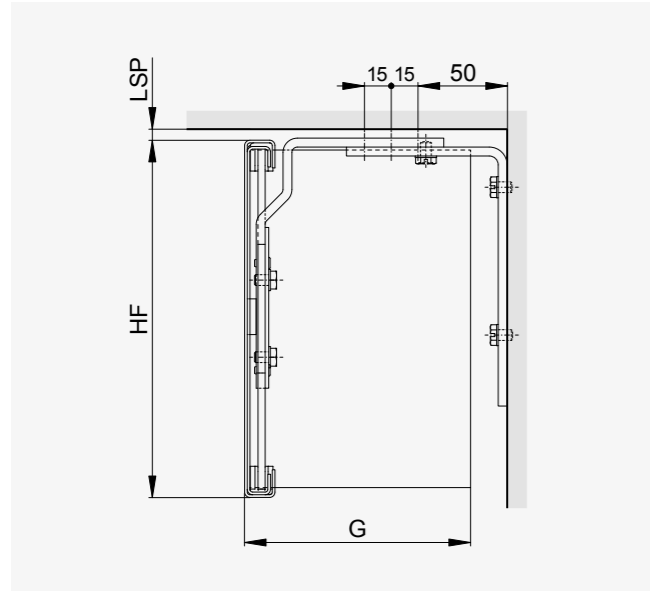

Corner connections	possible
Closing panel	loose or fixed
Clip, fastening	at top or rear

1.3 Straight cover.

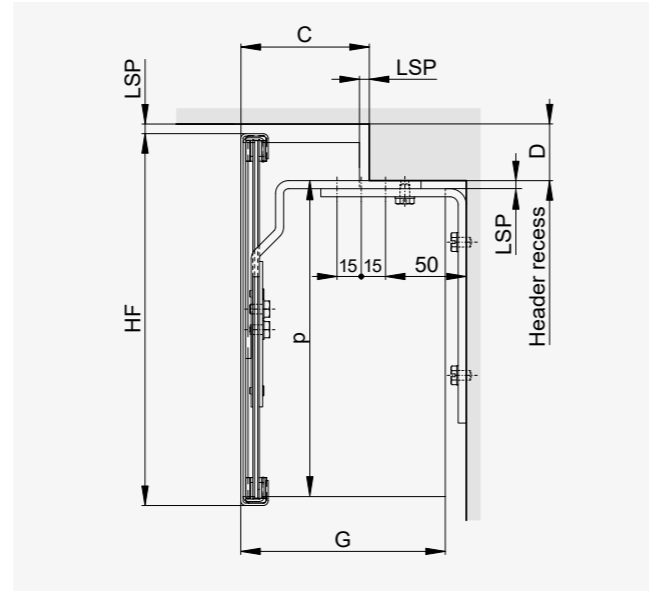

Corner connections	possible
Closing panel	loose or fixed
Clip, fastening	at top or rear

7.1 Soffit from 60 mm.

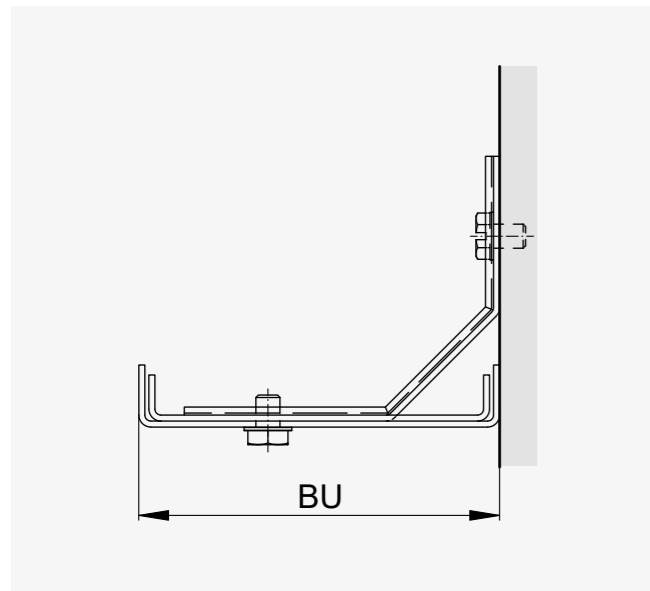

Corner connections	none
Clip, fastening	at rear or at front on clip

Covers. **Facade.**

8.1 Porch cover.

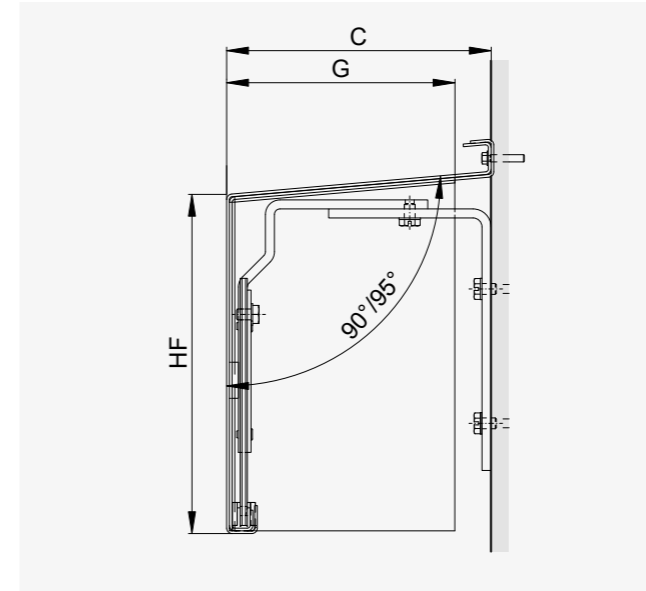

Corner connections	possible
Closing panel	loose or fixed
Clip, fastening	at rear
Option	with 90° (Depth C)

8.2 Porch cover below weatherboard.

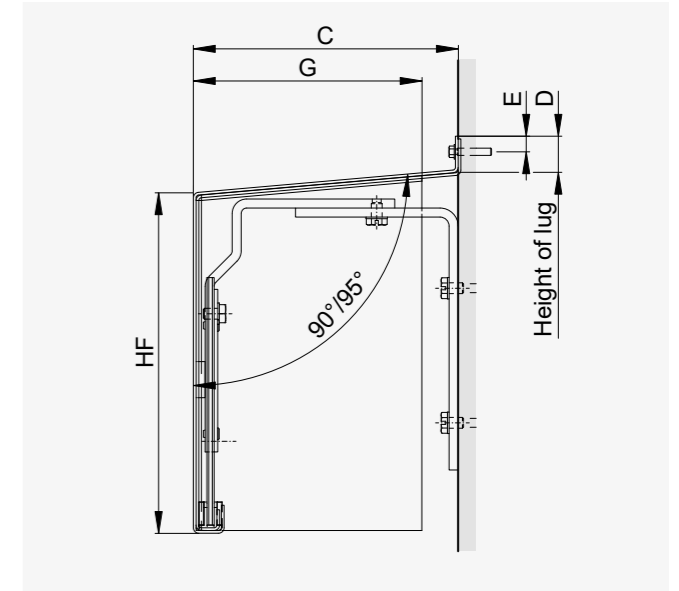

Corner connections	possible
Closing panel	loose or fixed
Clip, fastening	at rear
Option	with 90° (Depth C)
Option	ledge at bottom (D dimension)

HF Front height
 P Package height
 LSP Light gap
 G Closing panel depth
 C Front panel depth

The covers are 1.5 mm thick. The covers are cut to size and shaped before being powder-coated in-house, to avoid hairline coating cracks at the bend edges. The covers are manufactured to withstand proven EN13659:2015 wind strengths of 130 km/h and pressures of up to 800 N/m².



All covers in brief

The all-round feelgood package for your living and working space.

Discover the Griesser Smart Home and Smart Building controls. With their intelligent network credentials, these systems also offer open interfaces to outside products. Interconnected technology for optimum room comfort. Explore Griesser's unique trio of comfort dimensions.

⊕ Griesser's control solutions provide thermal and visual comfort and optimum privacy protection, all to ensure an ultimate feelgood living and working experience.

Visual comfort.

Griesser's Smart Home system gives you absolute control over the light coming into your home. Smart Home eliminates uncomfortable glare while simultaneously ensuring optimum light volumes – as much or as little light as you wish.

Thermal comfort.

Automatically operated solar shading maintains an optimum room ambience all year round. The system not only perfectly regulates inside temperatures: it lowers the need for heating and cooling, too. That saves energy to deliver a truly winning combination of feelgood comfort with strong sustainable credentials.

Protective comfort.

Griesser's Smart Home system does not just deliver welcome physical comfort: it provides reassuring protection of your personal privacy, too. So you can enjoy all the coziness of your own four walls free of prying eyes. Safe, secure and undisturbed: Smart Home offers it all.

Griesser Smart Home.

With its solar shading models, weather sensors, receivers and apps, Griesser has a wide range of systems to help you reliably network your solar shading facilities. And with their perfect interconnections, we'll provide you with a solar shading solution that is ideally tailored to your particular wishes and needs.

KNX house and building automation.

Griesser's KNX solar shading control option is an integrated master control system that boasts a broad range of functions to serve buildings of every size. With their tried-and-trusted features such as solar tracking and horizon limitation, KNX systems meet the highest demands of any solar shading controls.

BiLine radio control.

Griesser's BiLine control system blends contemporary design with high functional reliability through its routing technology. Radio control systems offer the key advantage of being easy to install, be it in new constructions or as retrofits to provide an existing building with automated systems control.



Live more sustainably. Save energy.



Visual comfort.
Visual privacy, glare protection and daylight regulation.



Thermal comfort.
An ideal indoor climate and high energy efficiency.



Protective comfort.
For greater privacy and seclusion.

Immerse yourself in the **Griesser color world.**

Choose from over 150 colors to harmonize your solar shading perfectly with your facade. The color of your blinds will be a combination of color shade, luminosity and texture. Components are provided as standard with a matt texture and a semi-gloss luminosity.

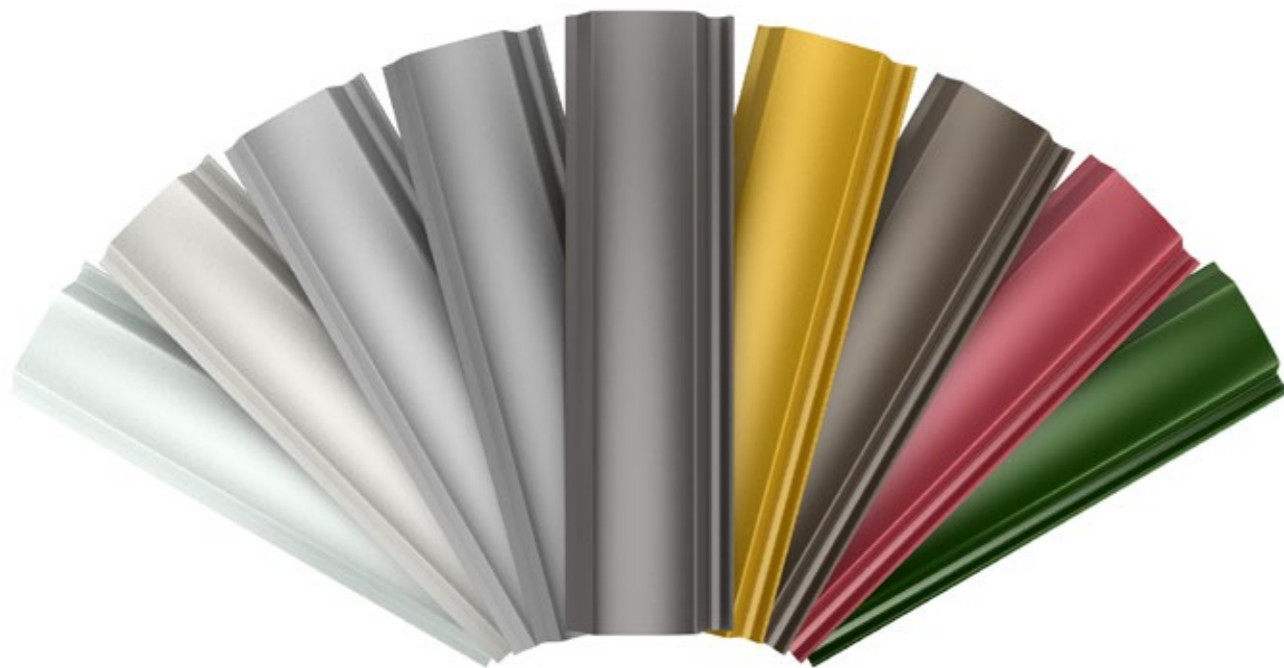

Create your color.

Instead of restricting you to silver, grey or black, Griesser invites you to simply choose your own favorite color. And if you can't see it in our range, you can bring us your favorite pullover or a sample of the color of your wall. We can then recreate the shade using our color spectrometer and blend it especially for you. So that your solar shading fits perfectly into your architecture's color concept.

Rich. Elegant. Optimally coated.

We want our products to be both durable and suitable for use in any situation. That's why we've developed an optimal coating for each of our products. It consists of the color shade, the luminosity level and the texture. The result: colors that are as rich and intense as you want them to be. For solar shading that reflects and absorbs just the right amount of light to suit the climate and the space. And for the final touch, we also provide additional particles that create a particularly elegant effect.

GriRAL.

Our GriRAL color collection consists of 50 different RAL color shades. From sand yellow to traffic white, we offer an extensive range of shades in every color segment. So we're convinced we have just the color shade, to meet your particular wishes and needs.

GriColors.

Our GriColors range, with its four collections of Glass & Stone, Sun & Fire, Water & Moss and Earth & Wood, offers some 100 color shades from cool whites to warm reds, natural blues and earthy browns.

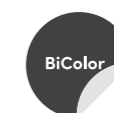

BiColor.

Slats in two colors: one for the interior and one for the outside world – that's the BiColor product. So for the outer face of your blinds, you can select a color for your slats that fits seamlessly into your facade in visual terms. And for the inner face of the blind, you can align your slats' color to the contents of the room. **Exclusively at Griesser.** Dare to be bold!

Note: With the BiColor version, a narrow strip of the outer color is visible on the inside of the blind for each slat.



Verified quality.

All the suppliers of our color lacquers and powders have earned themselves the globally recognized QUALICOAT quality seal of approval.



No more compromise with the BiColor option.
Slats coated in two distinct colors, one for inside and one for the outside look.

Metalunic® | Metalunic® Sinus dimensions.

Minimum and maximum dimensions by type of drive.

Operation	Width min. (bk)	Width ¹ max. (bk)	Height min. (bk)	Height max. (hl)	Surface ² max. (bk × hl)
Crank drive	500	2,800	440	4,000	6.5
Motor drive	700				8

Connected systems.

Operation	Width ¹ max. (bk)	Height max. (hl)	Blinds (max.)	Blinds per system	Surface ² max. [m ²]
Crank drive	8,400	4,000	3	2	5
				3	4
Motor drive	8,400	4,000	2	2	4.8

¹ The maximum value must be duly reduced on a case-by-case basis for high-rise structures and other buildings exposed to the wind.

² If crank drive is in slat area: maximum surface area and crank position available on request.

Minimum depth of header niche.

	Metalunic®	Metalunic® Sinus
Depth of niche* (tn)	min. 120	min. 120
A*/B	min. 60	min. 60

* Plus any addition required for protruding weatherboard or doorknob.

Minimum height of header niche.

Finished clear height (hl)	Metalunic® Niche height (hs)	Metalunic® Sinus Niche height (hs)
400-1,000	270	270
1,001-1,250	285	280
1,251-1,500	310	315
1,501-1,750	340	335
1,751-2,000	365	370
2,001-2,250	390	395
2,251-2,500	415	420
2,501-2,750	445	445
2,751-3,000	470	470
3,001-3,250	500	495
3,251-3,500	525	520
3,501-3,750	550	555
3,751-4,000	575	575

Header dimensions are approximate values which may exhibit negative or positive deviations depending on the technical circumstances.

Metalunic® | Metalunic® Sinus dimensions.

Technical details.

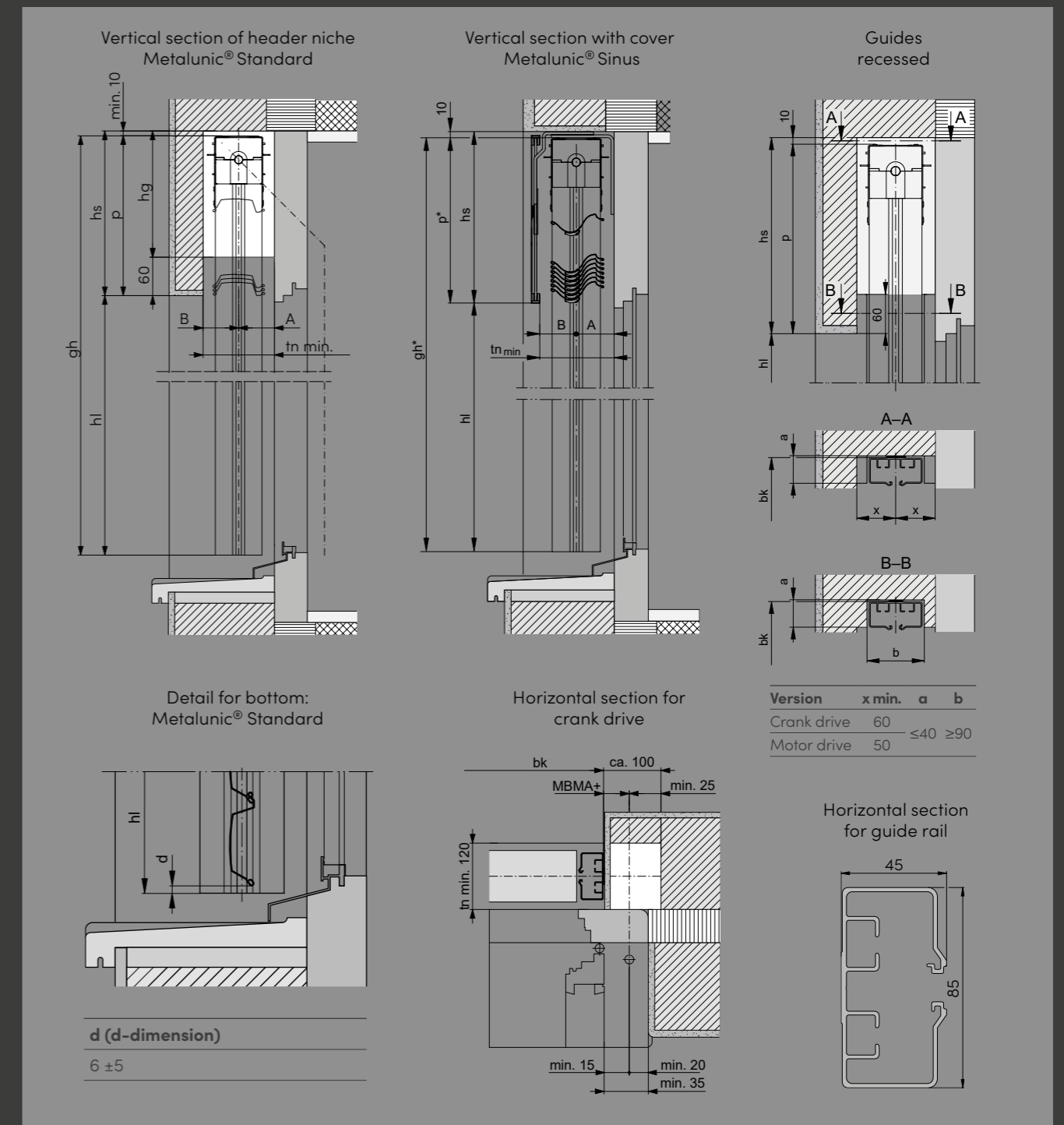

gh Overall height hl Finished clear height hs Height of header
Further technical details are available in the Short Guide at griesser.com.

Product variants.

Installation situations.

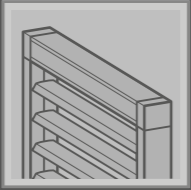
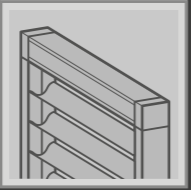
		
Installation location		
in header niche	■	■
beneath header	(■) ¹	(■) ¹
on facade	(■) ¹	(■) ¹
Type of installation		
self-supporting	■	■

¹ with cover.

Inclined installation.

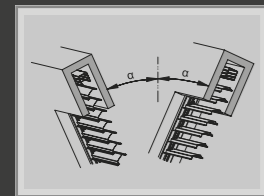

	Metalunic®	Metalunic® Sinus
Angle from the vertical [α]	max. 25°	-
Width max. (bk)	1,800	-

Reduce maximum loading with inclined installation by 20 %!
Protect blinds angled towards the outside from the effects of weathering (snow, ice).

Slats.

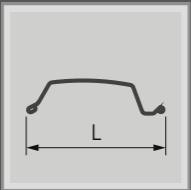
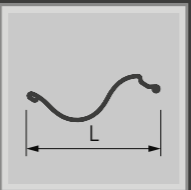
		
	Metalunic®	Metalunic® Sinus
Slat width (L)	96	92.6
Work Setting	45°/70°	45°/70°

Product variants.

Operation.

Drive (motor or crank)	Radio-less	Simple radio	Bi-directional radio	Crank
Elero	■	- ¹	BiLine ²	-
Somfy	■	- ³	- ⁴	-
Crank	-	-	-	■

Note: The IO receivers are not compatible with the soft-closing motor.

¹ An RTS radio receiver can be ordered separately.
Please note that the RTS radio receiver only works in conjunction with an Elero Soft motor.

² An IO radio receiver can be ordered separately.

Please note that the IO radio receiver only works in conjunction with an Elero Soft Motor.

³ An RTS radio receiver can be ordered separately.

⁴ An IO radio receiver can be ordered separately.

■ possible - not possible

Automation.

Smart Home		Smart Building	
Griesser BiLine	KNX	KNX	gBUS

Compatible with further controls: on request.

Wind categories.

Metalunic® | Metalunic® Sinus.

Product	Permissible wind resistance category thresholds ¹								
	1,500	2,000	2,500	3,000	3,500	4,000	4,500	5,000	
Metalunic® Metalunic® Sinus	[7]	[7]	[7]	[7]	6	-	-	-	

¹ Tests based on EN 13659 product norm. Product limit dimensions as per data sheet.
 [] No wind resistance category based on product norm; for meaning see below.

Setting values for sensors according to manufacturer.

Category 0	Category 1	Category 2	Category 3	Category 4	Category 5	Category 6	Category [7]	Category [8]
<9.0 m/s	9.0 m/s	10.7 m/s	12.8 m/s	16.7 m/s	21.0 m/s	25.6 m/s	29.2 m/s	33.3 m/s
<32.5 km/h	32.5 km/h	38.5 km/h	46 km/h	60 km/h	76 km/h	92 km/h	105 km/h	120 km/h

Setting for wind sensors if installed on the product.
 [] No wind resistance category based on product norm.

Corrosion classes.

Metalunic® | Metalunic® Sinus.

Product	Corrosion class
Metalunic®	4 ¹
Metalunic® Sinus	4 ¹

¹ Without the ProtectPLUS option, the product has corrosion class 3.

Tests and evaluations
 Salt spray tests conducted in accordance with ISO 9227.
 Visual inspections performed in accordance with EN 1670.

Corrosion classes as per EN 13659:2015.

Corrosion class	Applications	Length of testing
1	Little resistance Indoors in dry environments	24 h
2	Moderate resistance Indoors in environments where condensation may occur	48 h
3	High resistance Outdoors where damp, rain or dew may occasionally or frequently occur	96 h
4	Very high resistance Outdoors in very tough conditions	240 h

Fire protection categories.

Metalunic® | Metalunic® Sinus.

Product group	Venetian blinds
Blind/shutter material	Aluminum
Example	Metalunic®
Swiss VKF flammability group	RF1
Swiss VKF fire index number	6q.3
EU fire performance class under EN13501-1	A2-s1.d0
Description	(virtually) nonflammable

Product identification.

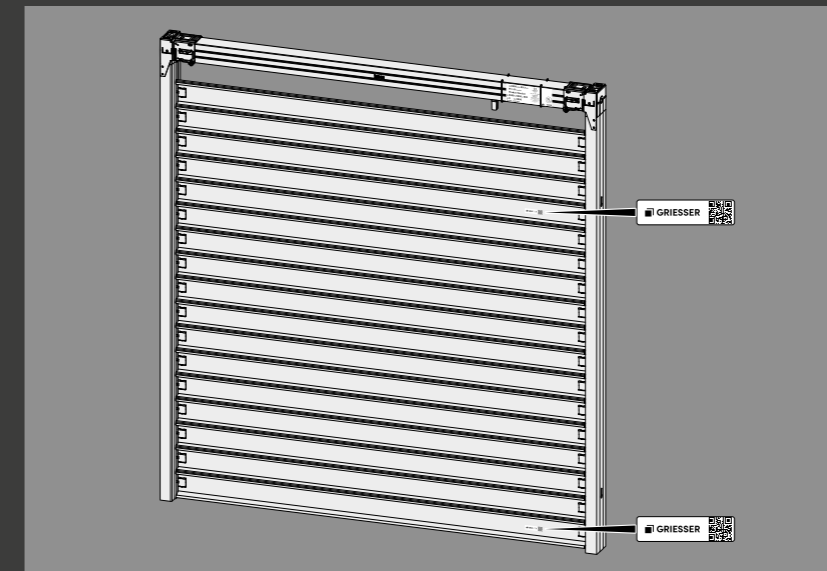

Griesser products are labelled with an individual QR code. Scanning this QR code provides a wealth of information and services.

Further information.



Total energy transmittance



Short manual External venetian blinds



Inspired by the **Sun.**



griesser.com

